

MİMARİ KATALOG :

Alüminyum Kapı Pencere ve
Giydirme Cephe Sistemleri



S28

RESCARA
SİSTEM
PROFİL
DETAYLARI



SİSTEM NUMARALARI

S28 F 01

S28 F 02

S28 F 03

S28 V 01

S28 V 02

PROFİL NUMARALARI

1011

1002

1001

1003

1004

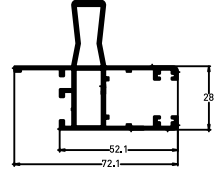
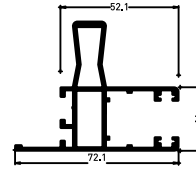
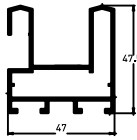
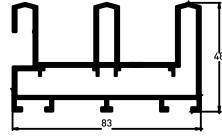
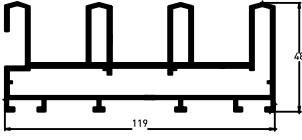

AĞIRLIK (kg/mt)

2.575

1.850

1.028

1.238

1.238

Jx - Jy (cm⁴)

18.33 - 136.5

14.09 - 51.77

8.62 - 11.03

14.83 - 12.46

14.83 - 12.46

SİSTEM NUMARALARI

S28 V 03

S28 M 01

S28 G 01

S28 G 02

S28 A 01

PROFİL NUMARALARI

1005

1010

1006

1007

1008

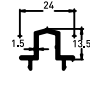
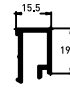
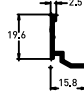
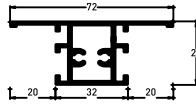
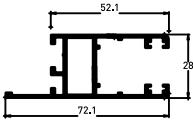

AĞIRLIK (kg/mt)

0.912

0.979

0.163

0.270

0.209

Jx - Jy (cm⁴)

4.30 - 11.72

3.62 - 7.86

SİSTEM NUMARALARI

S28 A 02

PROFİL NUMARALARI

1009

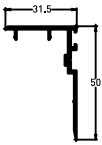

AĞIRLIK (kg/mt)

0.374

Jx - Jy (cm⁴)

SİSTEM NUMARALARI

PROFİL NUMARALARI

AĞIRLIK (kg/mt)

Jx - Jy (cm⁴)



SİSTEM DETAYLARI

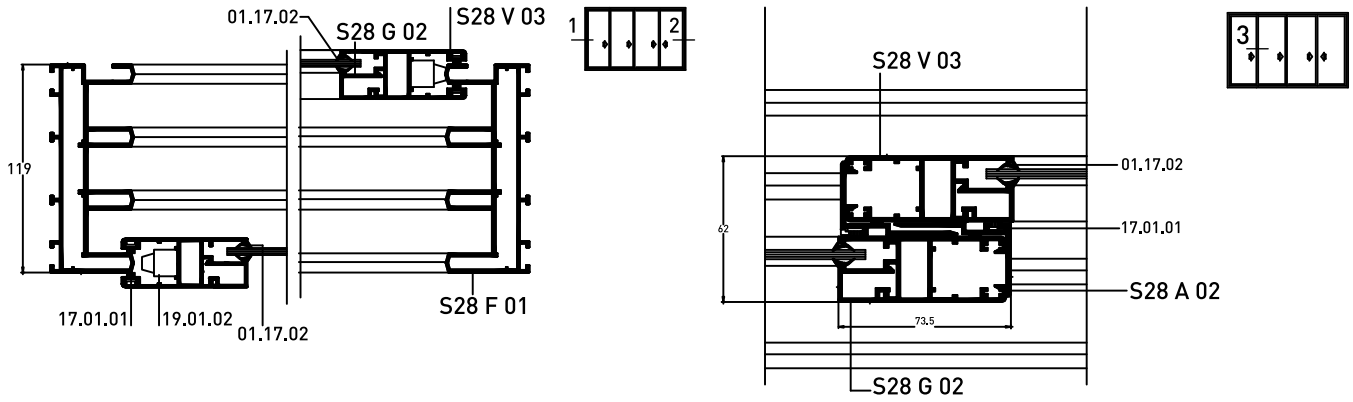

SİSTEM DETAYLARI

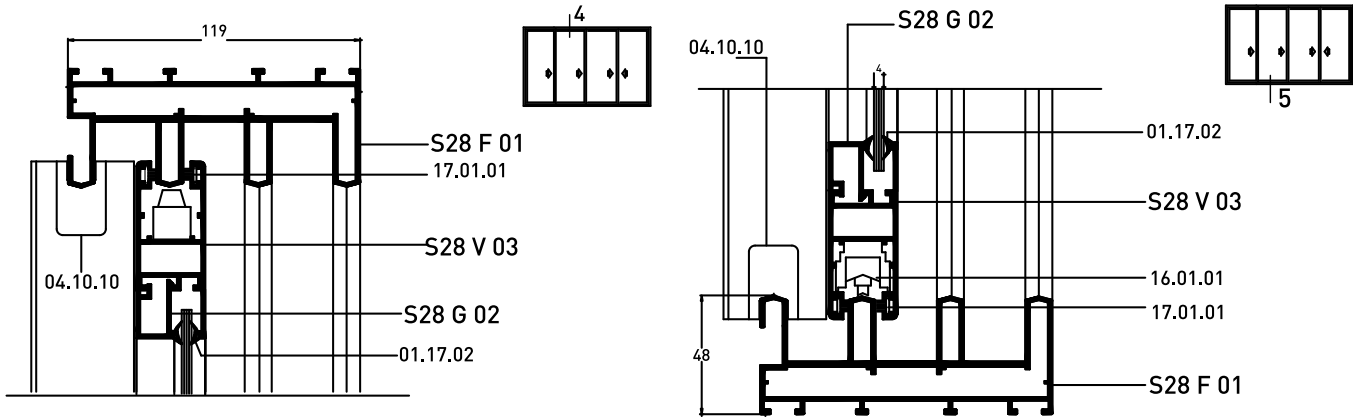

SİSTEM DETAYLARI

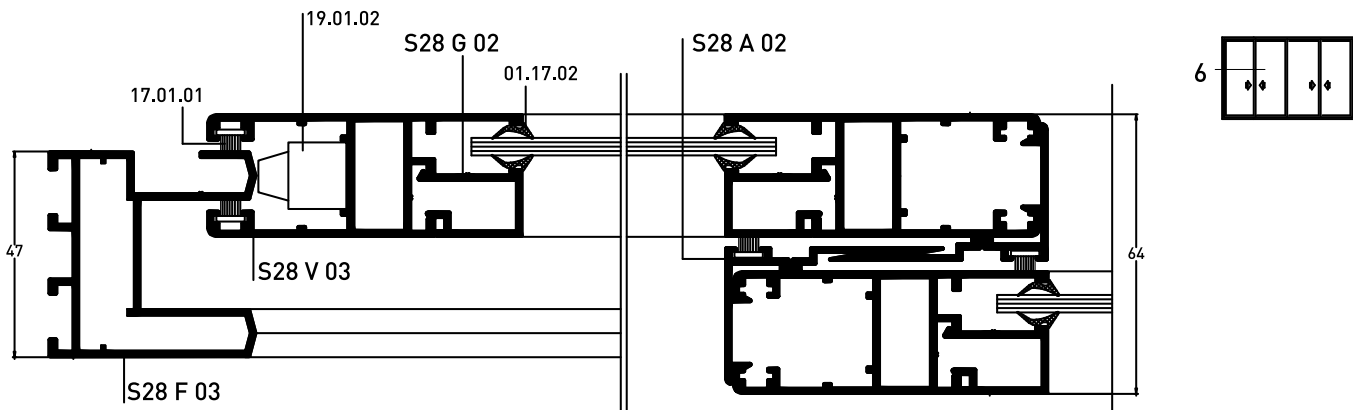

SİSTEM DETAYLARI

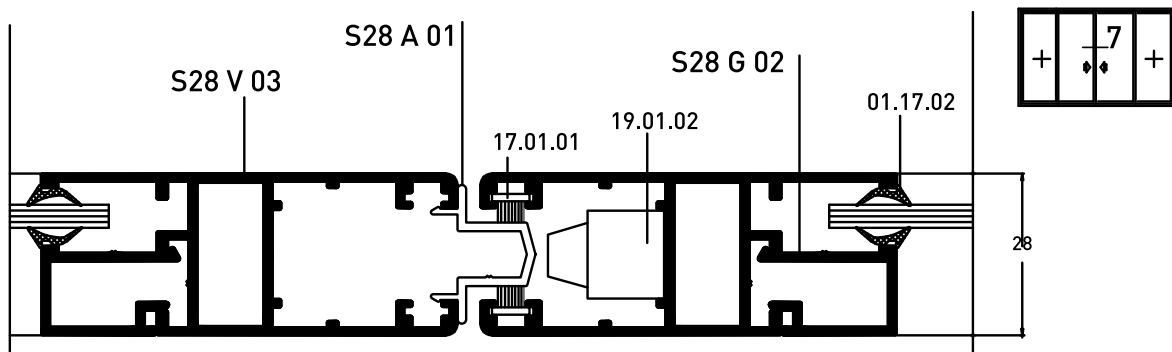



SİSTEM DETAYLARI

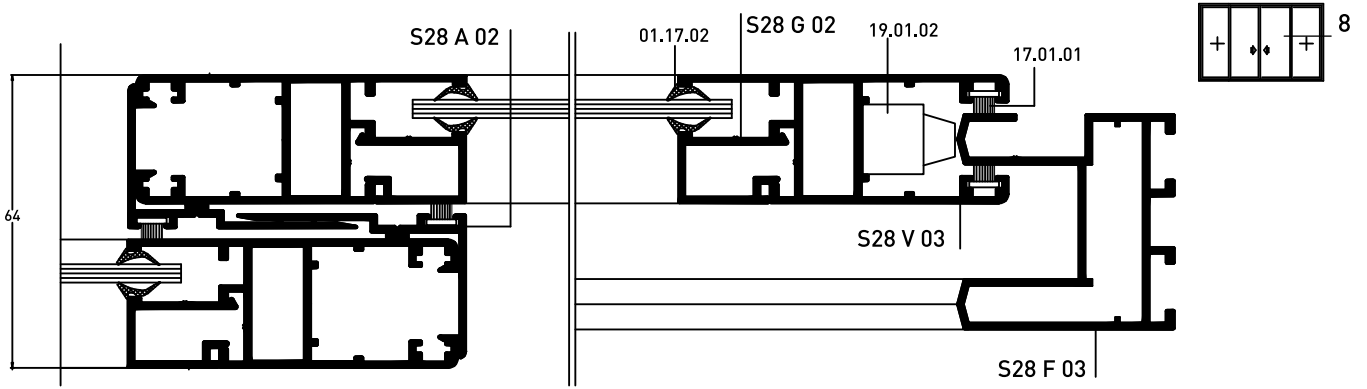

SİSTEM DETAYLARI

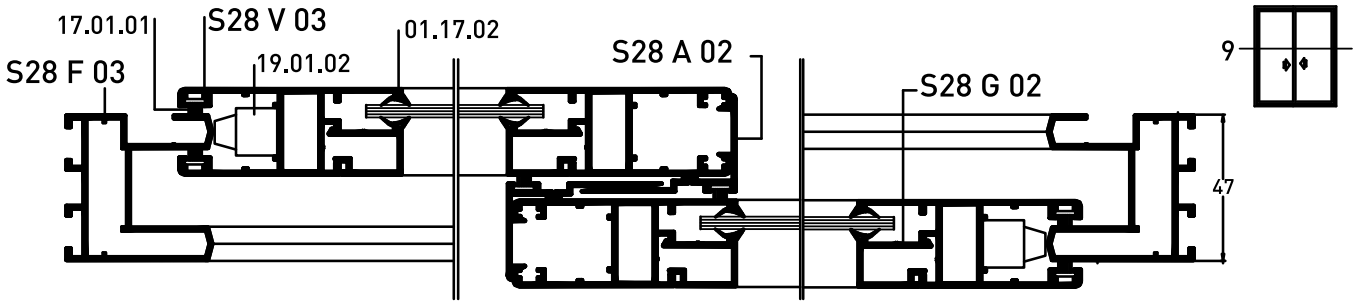

SİSTEM DETAYLARI

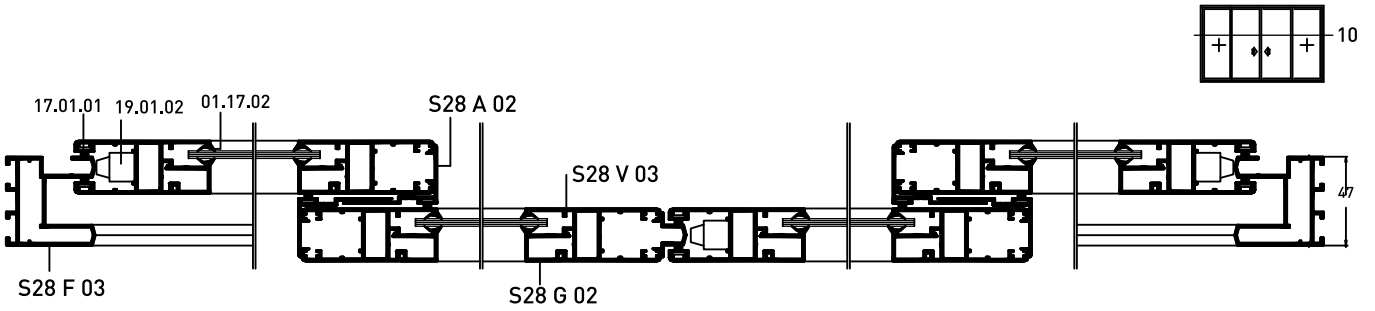

SİSTEM DETAYLARI

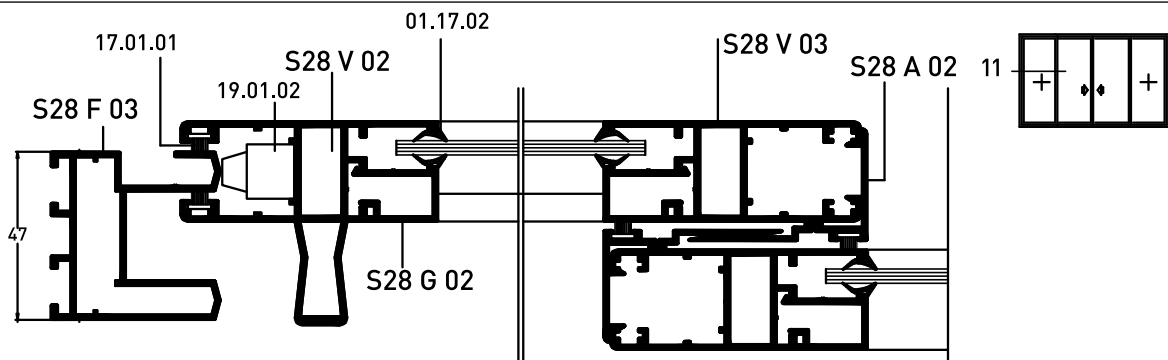



SİSTEM DETAYLARI

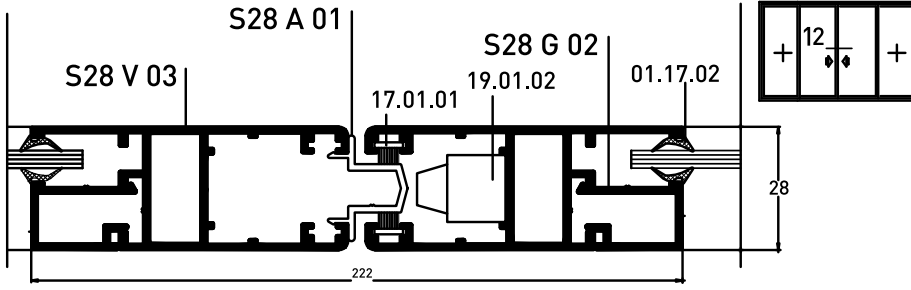

SİSTEM DETAYLARI

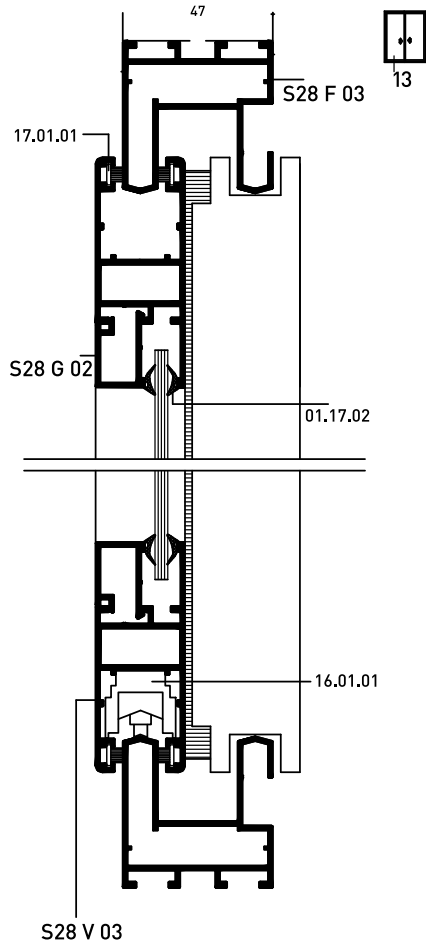



SİSTEM DETAYLARI



KÖŞE TAKOZLARI

KÖŞE TAKOZLARI

Nr		 L m	KESİM ÖLÇÜSÜ	 PARÇA KOD NUMARASI
S28 F 01	1011	25 L 13 (2058)	10,6 mm	218 L 13
S28 F 02	1002	25 L 13 (2058)	23,9 mm	130 L 13
S28 F 03	1001	25 L 13 (2058)	41,1 mm	217 L 13
S28 V 01	1003	25 L 28 (10542)	24,3 mm	186 L 28
S28 V 02	1004	25 L 28 (10542)	24,3 mm	186 L 28
S28 V 03	1005	25 L 28 (10542)	24,3 mm	186 L 28

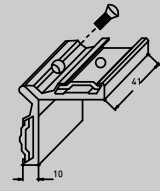
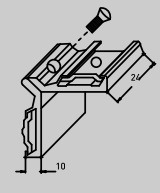
KÖŞE TAKOZU	KOD	KULL. PROFİL
	10.02.01	S28 F 01 S28 F 03
	10.02.02	S28 F 02 S28 V 01 S28 V 02 S28 V 03

KESİM ÖLÇÜSÜ

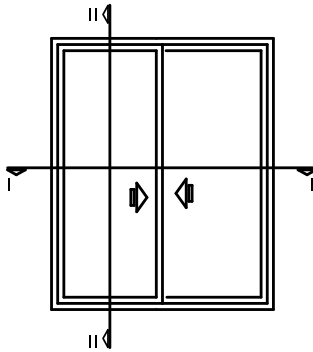
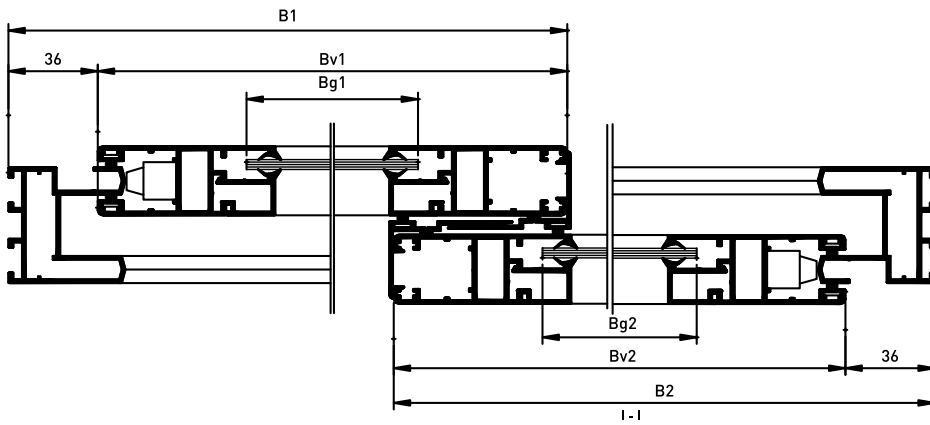



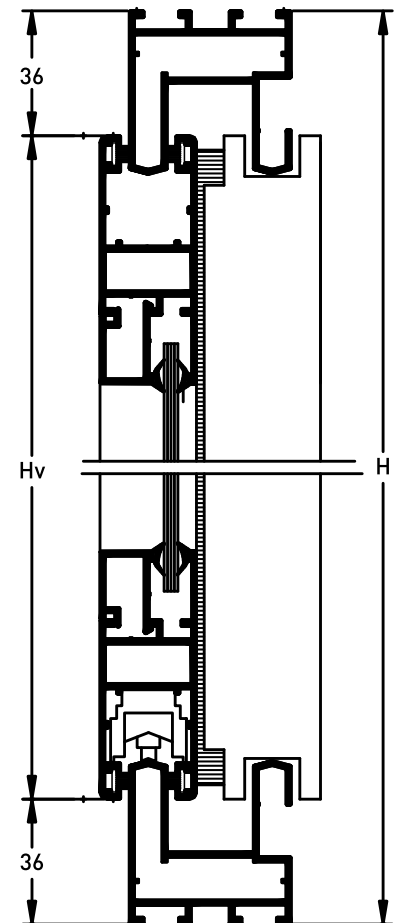







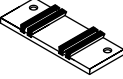





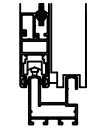
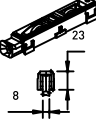
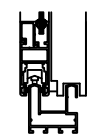

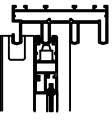

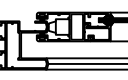
CAM ÖLÇÜSÜ	Bg1=B1-158
	Bg2=B2-158
	Hg=H-192
KASA - KANAT ÖLÇÜSÜ	Bv1=B1-36
	Bv2=B2-36
	Hv=H-72

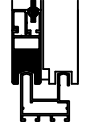

II - II



RESİM	KOD	AÇIKLAMA	KULL. ŞEKLİ	RESİM	KOD	AÇIKLAMA	KULL. ŞEKLİ	RESİM	KOD	AÇIKLAMA	KULL. ŞEKLİ
	01.17.01 EPDM	İÇ CAM FİTİLİ			04.04.01	TOZLUK PARÇASI					
AĞIRLIK= 0.062 kg/m											
	01.17.02 EPDM	İÇ CAM FİTİLİ									
AĞIRLIK= 0.054 kg/m											
	17.01.01 EPDM	FIRÇA FİTİL									
	16.01.01	TEKLI RULMAN									
	16.01.02	AYARLI ÇİFTLİ RULMAN									
	19.01.01	ÜST STOPER									
	19.01.02	YAN STOPER									
	04.10.10	ALT KAPAK									
	04.03.01	KÖŞE BAĞLANTI									
	07.10.01	SÜRME KOL									
	16.04.02	SÜRME KİLİT DİLİ									
	16.05.02	SÜRME KİLİT KARŞILIĞI									